

LS884TM1-WRC

Point Source LED

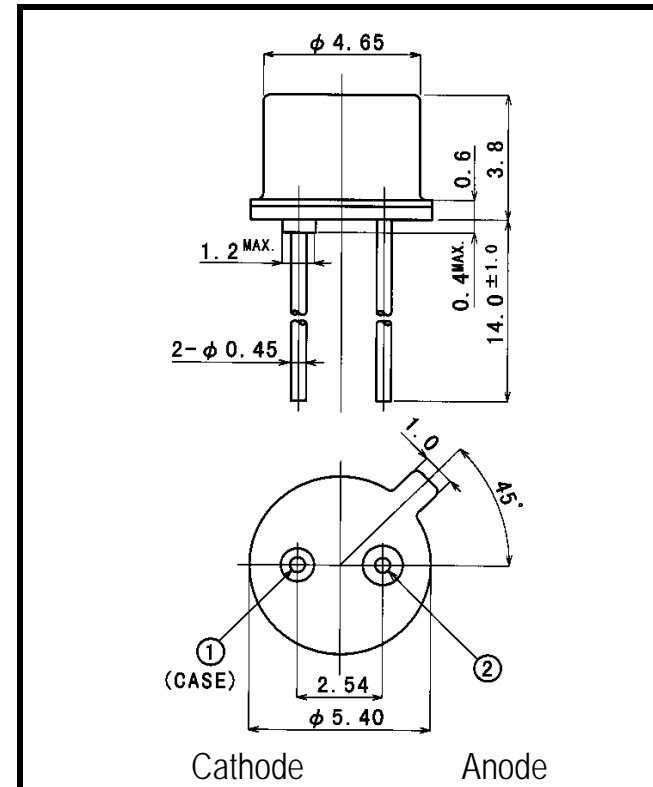

- FEATURES**
- Point-Source LED
 - Emitting Window Dia. 50 μm
 - High-output Power
 - Small Temp. Coefficient of PO
 - High Reliability in Demanding Environments
- APPLICATIONS**
- Optical Switches
 - Optical Instruments

1. ABSOLUTE MAXIMUM RATINGS (Ta=25 °C)

ITEM	SYMBOL	RATINGS	UNIT
Forward Current (DC)	IF	80	mA
Forward Current (Pulse)*1	IFP	0.4	A
Reverse Voltage	VR	5	V
Power Dissipation	PD	150	mW
Operating Temp.	Topr	-30 TO 100	
Storage Temp.	Tstg	-40 TO 125	
Junction Temp.	Tj	125	
Lead Soldering Temp.*2	Tls	260	

*1:Tw=10uS,T=10mS

*2:Time 5 Sec max,Position:Up to 3mm from the body

2. ELECTRICAL & OPTICAL CHARACTERISTICS (Ta=25 °C)

ITEM	SYMBOL	CONDITIONS	MIN	TYP	MAX	UNIT
Power Output	PO	IF=50mA	1.6	2.7		mW
Forward Voltage	VF	IF=50mA		1.9	2.4	V
Reverse Current	IR	VR=5V			10	μA
Peak Wavelength	λp	IF=50mA	850	880		nm
Spectral Line Half Width		IF=50mA		40		nm
Half Intensity Beam Angle		IF=50mA		±45		deg.
Band Width	fc	IF=50mA+20mA _{p-p}		20		MHz
Junction Capacitance	Cj	1MHz, V=0V		40		pF
Temp. Coefficient of PO	P/T	IF=10mA		-0.05		%/°C
Temp. Coefficient of VF	V/T	IF=10mA		-2.3		mV/°C

SPECTRAL OUTPUT

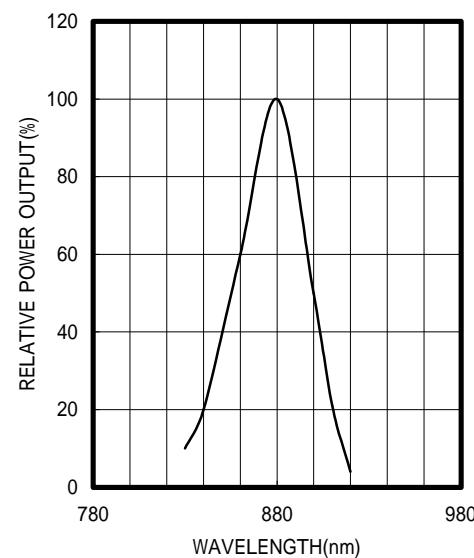

FORWARD I-V CHARACTERISTICS

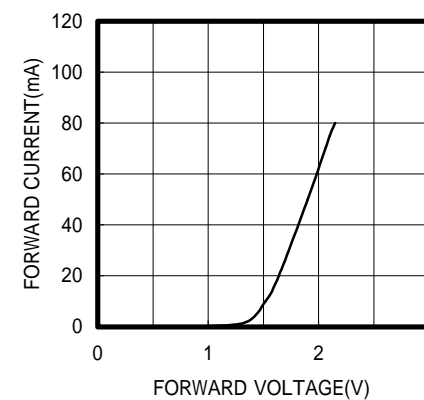

RELATIVE POWER vs FORWARD CURRENT

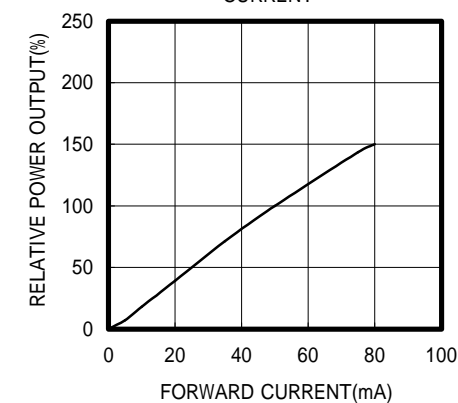

RADIATION PATTERN

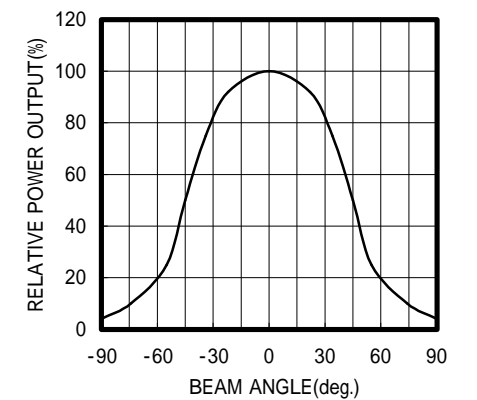

THERMAL DERATING CURVE

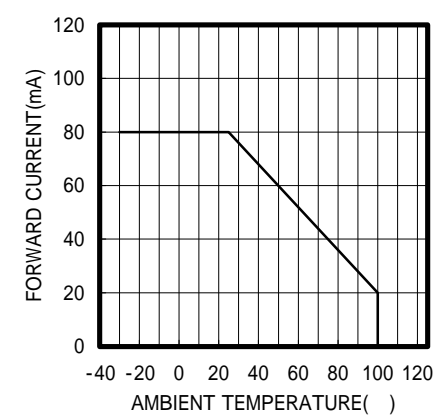

POWER OUTPUT vs TEMPERATURE IF=10mA

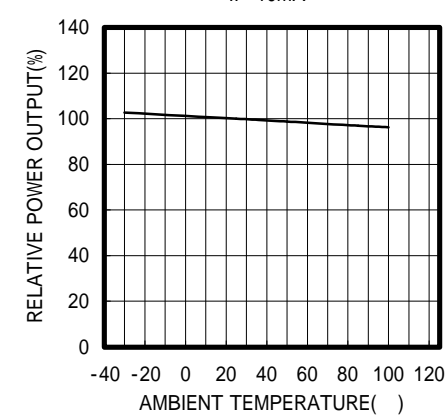

FORWARD VOLTAGE vs TEMPERATURE IF=10mA

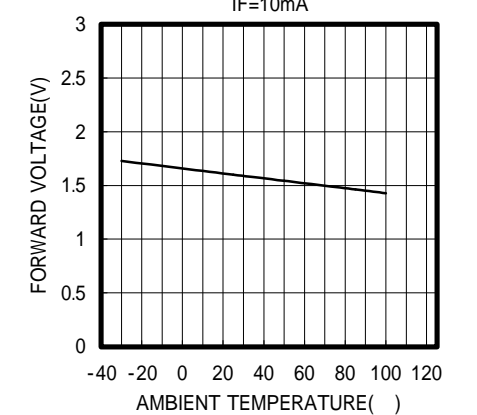

OPTRANS

2-6-11 MASUKATA, TAMA-KU, KAWASAKI 214-0032. JAPAN
TEL.81(44)932-6491 / FAX.81(44)932-8281
E-mail optrans@mb.kcom.ne.jp