

LS946SMCP

Infrared Emitting Diode

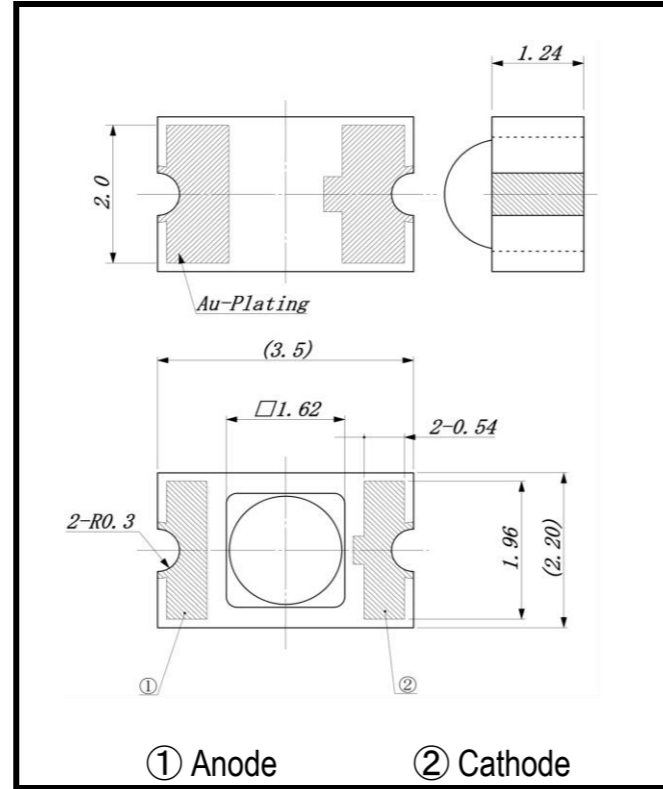
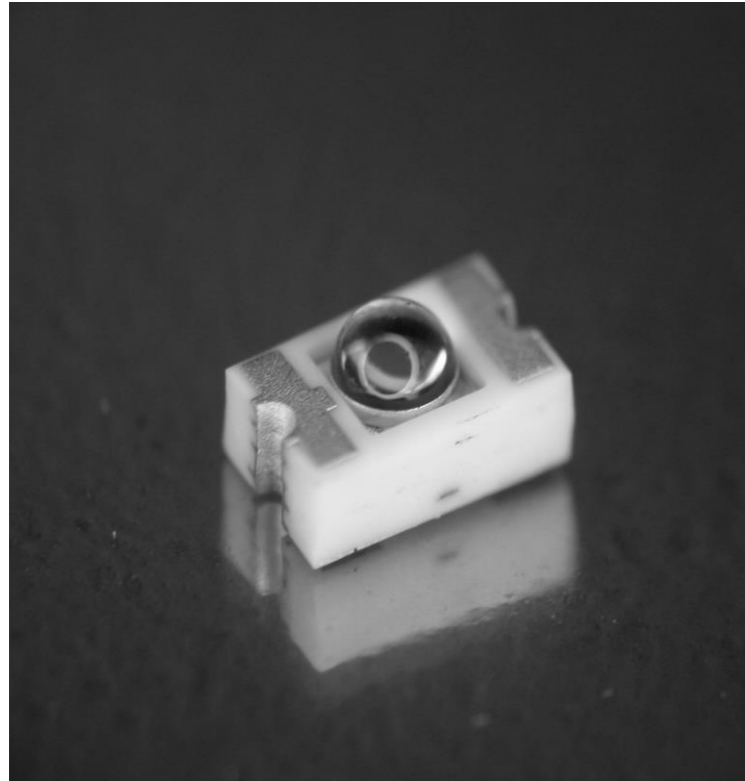

2. ELECTRICAL & OPTICAL CHARACTERISTICS (Ta=25°C)

ITEM	SYMBOL	CONDITIONS	MIN	TYP	MAX	UNIT
Power Output	PO	IF=50mA		10.0		mW
Forward Voltage	VF	IF=50mA		1.30	1.9	V
Reverse Current	IR	VR=5V			100	μA
Peak Wavelength	λ_p	IF=50mA		950		nm
Spectral Line Half Width	$\Delta\lambda$	IF=50mA		40		nm
Half Intensity Beam Angle	θ	IF=50mA		±15		deg.

FEATURES · High-output Power

APPLICATIONS · Optical Switches
 · Bar-code Reader
 · Fiber Optical Communications

1. ABSOLUTE MAXIMUM RATINGS (Ta=25°C)

ITEM	SYMBOL	RATINGS	UNIT
Forward Current (DC)	IF	80	mA
Forward Current (Pulse)*1	IFP	0.5	A
Reverse Voltage	VR	5	V
Power Dissipation	PD	160	mW
Operating Temp.	Topr	-20 TO 80	°C
Storage Temp.	Tstg	-30 TO 100	°C
Junction Temp.	Tj	100	°C
Lead Soldering Temp.	Tls	260	°C

*1: Tw=10μs, T=10mS

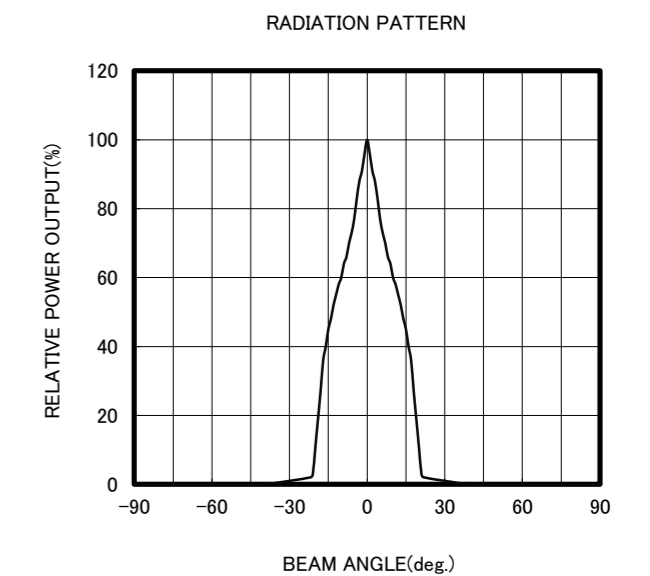
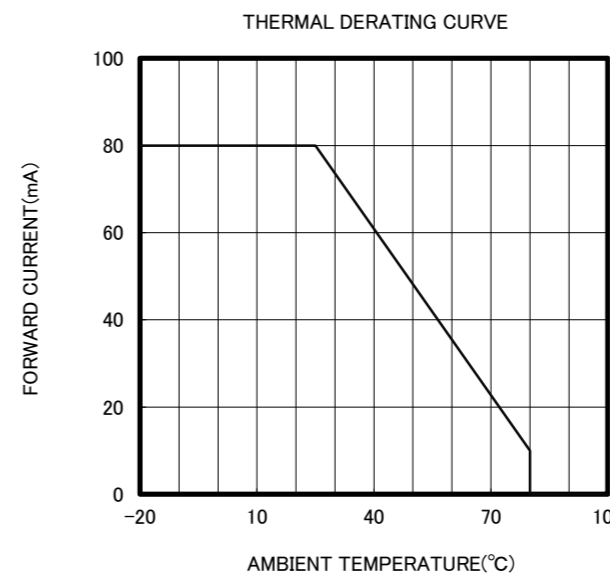
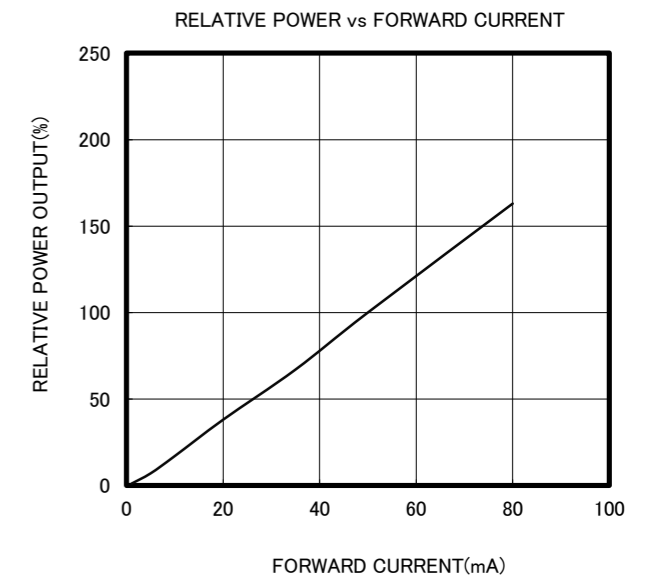
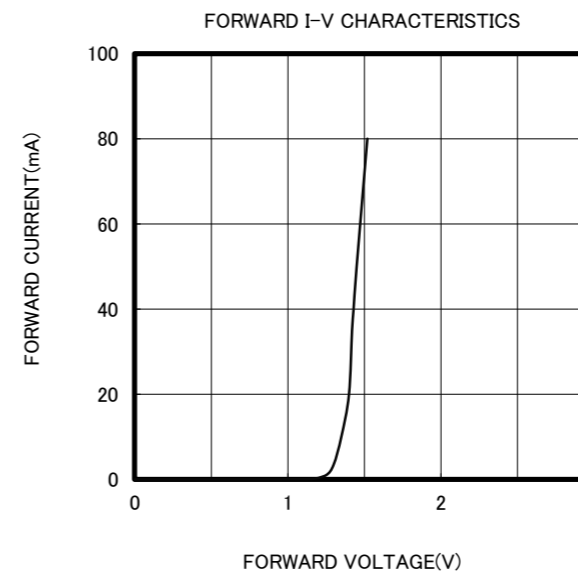
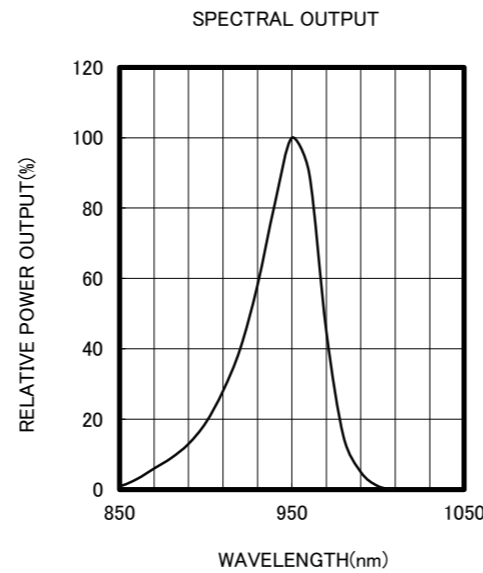

OPTRANS

241, NOBORITO, TAMA-KU, KAWASAKI 214-0014, JAPAN
 TEL.81(44)932-6491 / FAX.81(44)932-8281
 E-mail optrans@optrans.com