

LSF860N5

Infrared Emitting Diode

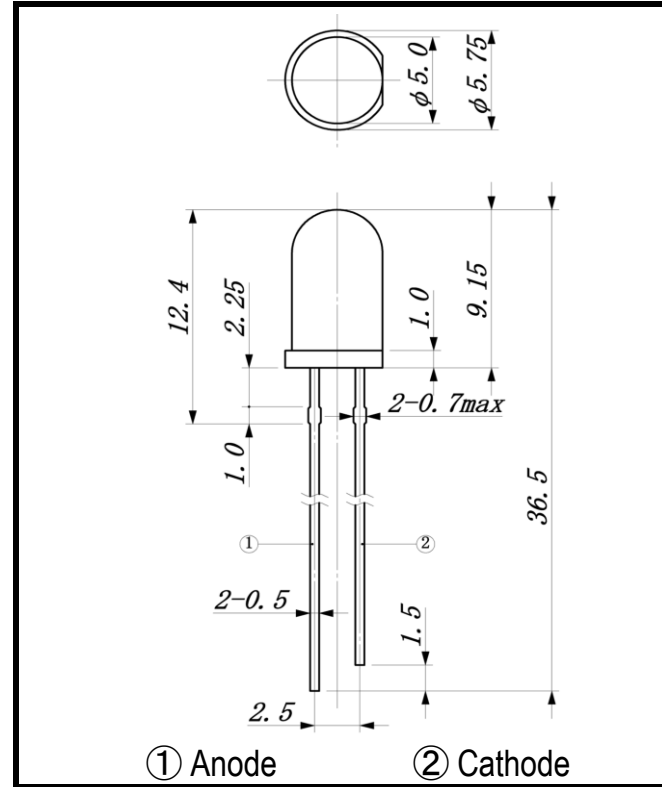
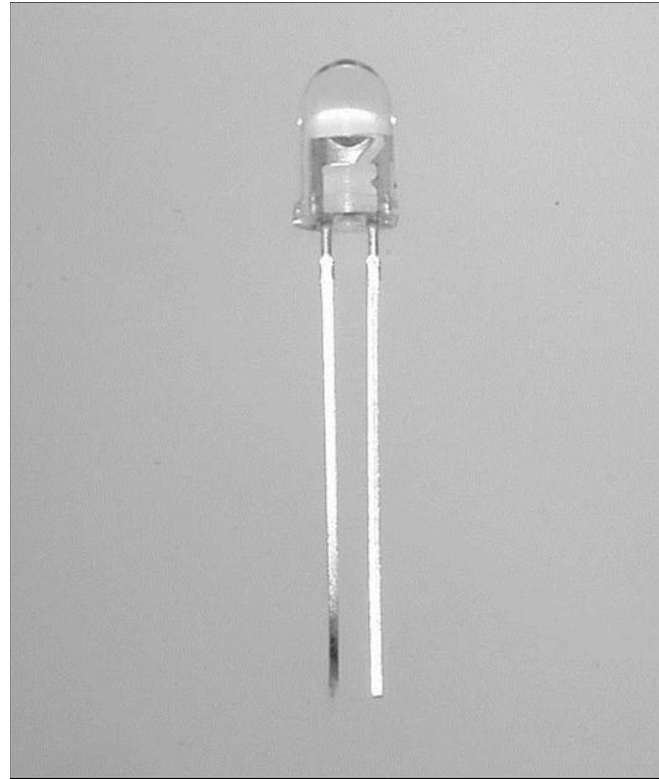

2. ELECTRICAL & OPTICAL CHARACTERISTICS (Ta=25°C)

ITEM	SYMBOL	CONDITIONS	MIN	TYP	MAX	UNIT
Power Output	PO	IF=50mA		25.0		mW
Forward Voltage	VF	IF=50mA		1.45	1.9	V
Reverse Current	IR	VR=5V			100	μA
Peak Wavelength	λ _p	IF=50mA		850		nm
Spectral Line Half Width	Δλ	IF=50mA		30		nm
Half Intensity Beam Angle	θ	IF=50mA		±8		deg.

- FEATURES**
- High-output Power
 - Narrow Beam Angle
 - High Reliability
- APPLICATIONS**
- Optical Switches
 - Bar-code Reader

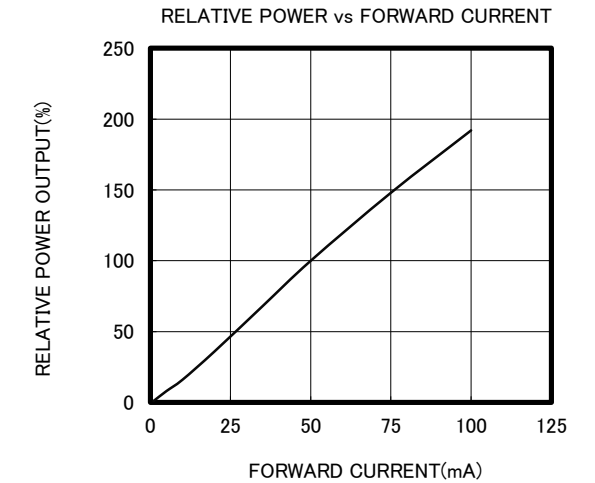
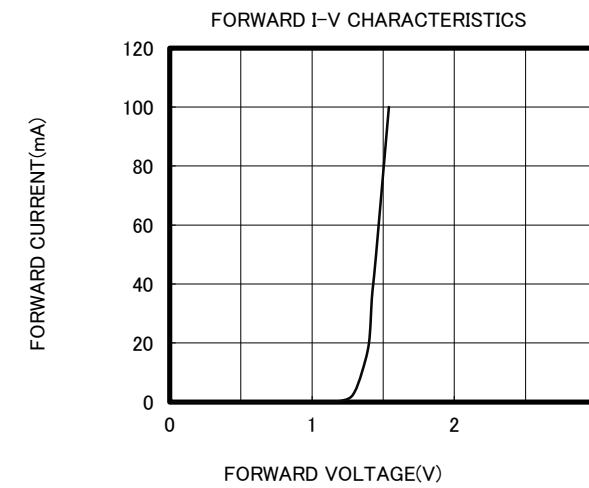

1. ABSOLUTE MAXIMUM RATINGS (Ta=25°C)

ITEM	SYMBOL	RATINGS	UNIT
Forward Current (DC)	IF	100	mA
Forward Current (Pulse)*1	IFP	1	A
Reverse Voltage	VR	5	V
Power Dissipation	PD	190	mW
Operating Temp.	Topr	-20 TO 80	°C
Storage Temp.	Tstg	-30 TO 100	°C
Junction Temp.	Tj	100	°C
Lead Soldering Temp.*2	Tls	260	°C

*1:Tw=10uS,T=10mS

*2:Time 5 Sec max,Position:Up to 3mm from the body

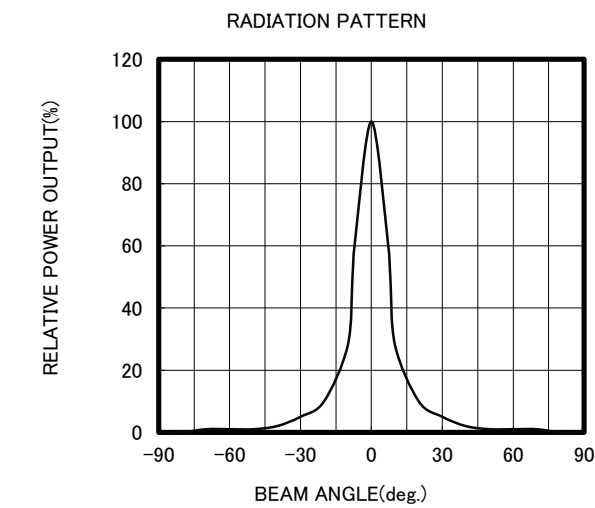
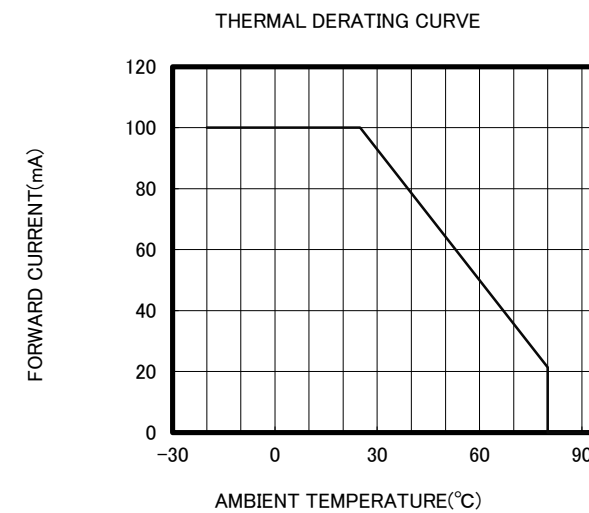
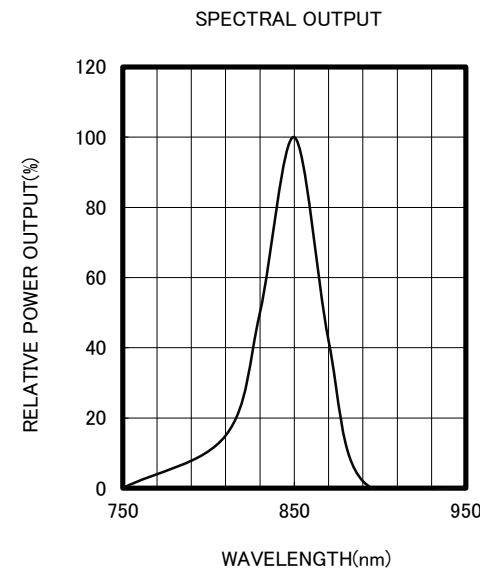

OPTRANS

241, NOBORITO, TAMA-KU, KAWASAKI 214-0014, JAPAN
 TEL.81(44)932-6491 / FAX.81(44)932-8281
 E-mail optrans@optrans.com