

# VSC614M3A

# Visible Light Emitting Diode

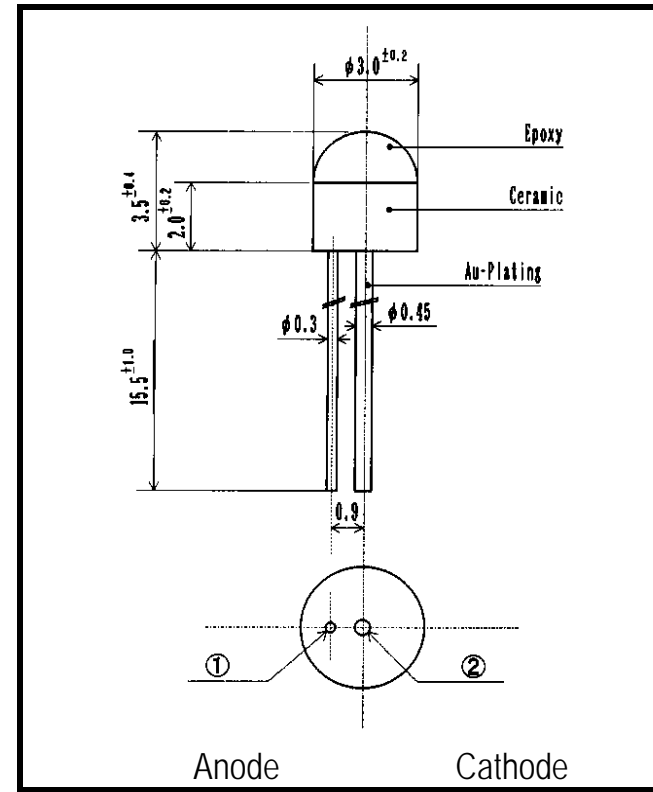

- FEATURES**
- High-Power output
  - Wide Viewing Angle
  - Compact
- APPLICATIONS**
- Display
  - Indicators
  - Light-source for Sensor
  - Optical Switches

## 1. ABSOLUTE MAXIMUM RATINGS(Ta=25 °C)

ITEM	SYMBOL	RATINGS	UNIT
Forward Current (DC)	IF	30	mA
Forward Current (Pulse)*1	IFP	0.3	A
Reverse Voltage	VR	5	V
Power Dissipation	PD	75	mW
Operating Temp.	Topr	-20 TO 80	
Storage Temp.	Tstg	-30 TO 100	
Junction Temp.	Tj	100	
Lead Soldering Temp.*2	Tls	260	

\*1:Tw=10uS,T=10mS

\*2:Time 5 Sec max,Position:Up to 3mm from the body

## 2. ELECTRICAL & OPTICAL CHARACTERISTICS (Ta=25 °C)

ITEM	SYMBOL	CONDITIONS	MIN	TYP	MAX	UNIT
Power Output	PO	IF=20mA	0.9	1.7		mW
Forward Voltage	VF	IF=20mA		2.0	2.4	V
Reverse Current	IR	VR=5V			100	μA
Peak Wavelength	λp	IF=20mA		610		nm
Spectral Line Half Width		IF=20mA		17		nm
Half Intensity Beam Angle		IF=20mA		±80		deg.
Rise Time	Tr	IFP=20mA		-		nS
Fall Time	Tf	IFP=20mA		-		nS
Junction Capacitance	Cj	1MHz, V=0V		20		pF
Temp. Coefficient of PO	P/T	IF=10mA		-0.8		%/°C
Temp. Coefficient of VF	V/T	IF=10mA		-1.7		mV/°C

SPECTRAL OUTPUT

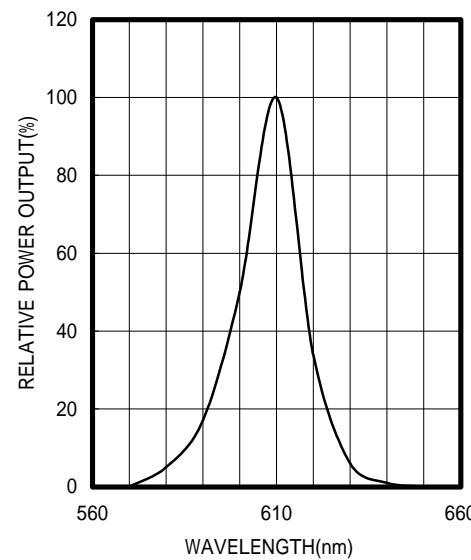

FORWARD I-V CHARACTERISTICS

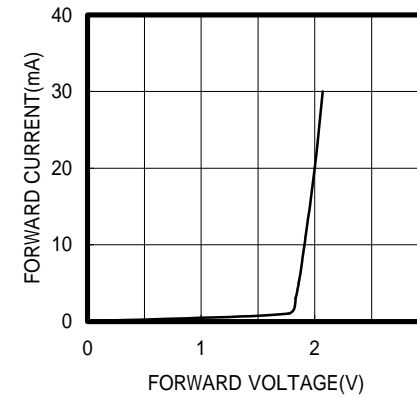

RELATIVE POWER vs FORWARD CURRENT

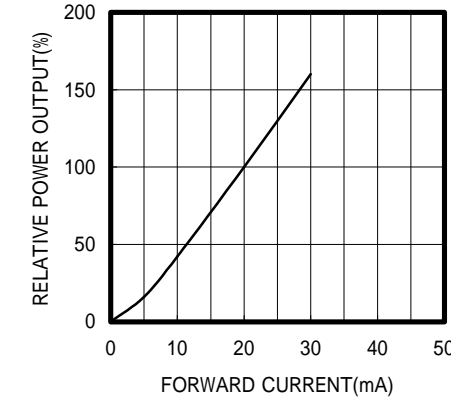

RADIATION PATTERN

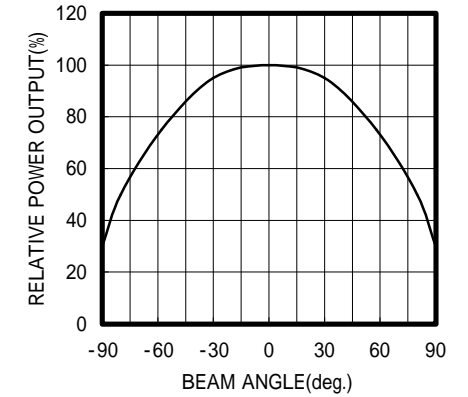

THERMAL DERATING CURVE

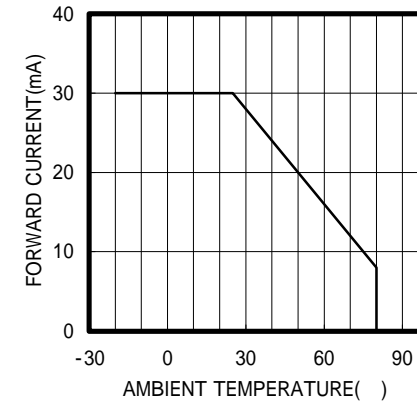

POWER OUTPUT vs TEMPERATURE IF=10mA

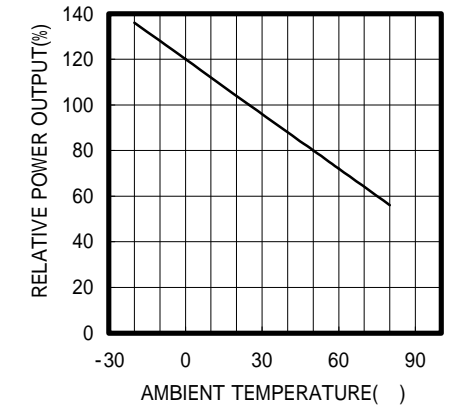

FORWARD VOLTAGE vs TEMPERATURE IF=10mA

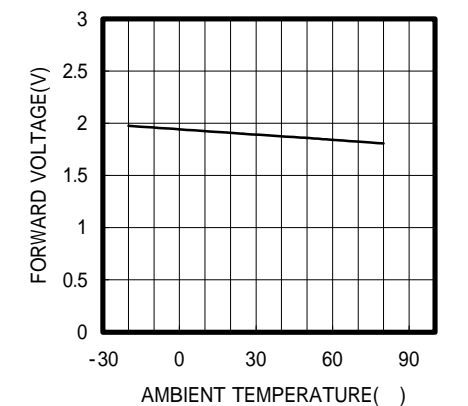

OPTRANS

2-6-11 MASUKATA, TAMA-KU, KAWASAKI 214-0032. JAPAN  
 TEL.81(44)932-6491 / FAX.81(44)932-8281  
 E-mail optrans@mb.kcom.ne.jp