

# VSF666N3

# Visible Light Emitting Diode

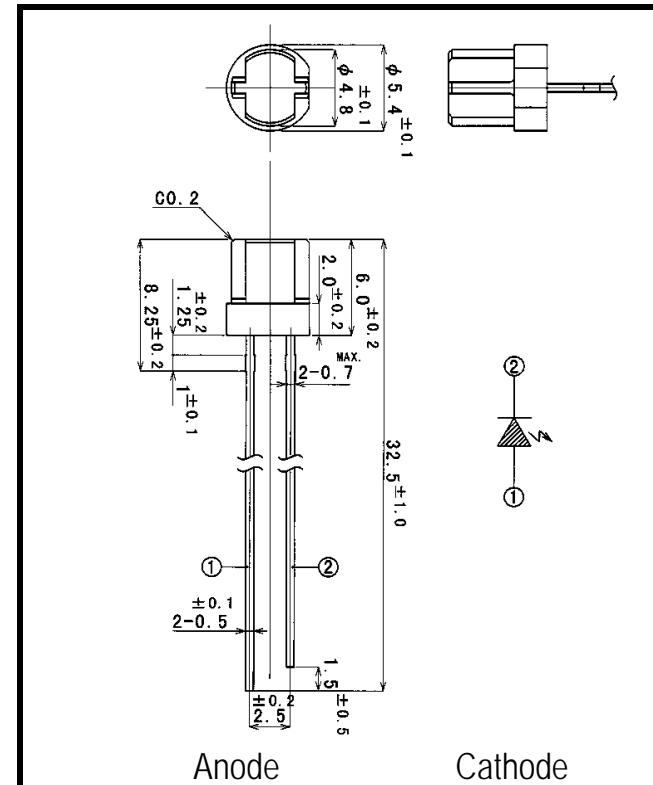

- FEATURES**
- High Output Power
  - Wide Beam Angle
- APPLICATIONS**
- Fiber Optical Communications
  - Optical Sensor
  - Bar-code Reader
  - Edge Sensing (Coin Dispenser)

## 1. ABSOLUTE MAXIMUM RATINGS (Ta=25 )

ITEM	SYMBOL	RATINGS	UNIT
Forward Current (DC)	IF	50	mA
Forward Current (Pulse)*1	IFP	0.5	A
Reverse Voltage	VR	5	V
Power Dissipation	PD	120	mW
Operating Temp.	Topr	-20 TO 80	
Storage Temp.	Tstg	-30 TO 100	
Junction Temp.	Tj	100	
Lead Soldering Temp.*2	Tls	260	

\*1:Tw=10uS,T=10mS  
\*2:Time 5 Sec max,Position:Up to 3mm from the body

## 2. ELECTRICAL & OPTICAL CHARACTERISTICS (Ta=25 )

ITEM	SYMBOL	CONDITIONS	MIN	TYP	MAX	UNIT
Power Output	PO	IF=20mA		5.0		mW
Forward Voltage	VF	IF=20mA		1.8	2.2	V
Reverse Current	IR	VR=5V			100	μA
Peak Wavelength	λ	IF=20mA		660		nm
Spectral Line Half Width		IF=20mA		25		nm
Half Intensity Beam Angle		IF=20mA		±55		deg.
Rise Time	Tr	IFP=20mA		30		nS
Fall Time	Tf	IFP=20mA		30		nS
Junction Capacitance	Cj	1MHz ,V=0V		20		pF
Temp. Coefficient of PO	P/T	IF=10mA		-0.5		%/
Temp. Coefficient of VF	V/T	IF=10mA		-1.5		mV/

Dimensions (Unit:mm)

SPECTRAL OUTPUT

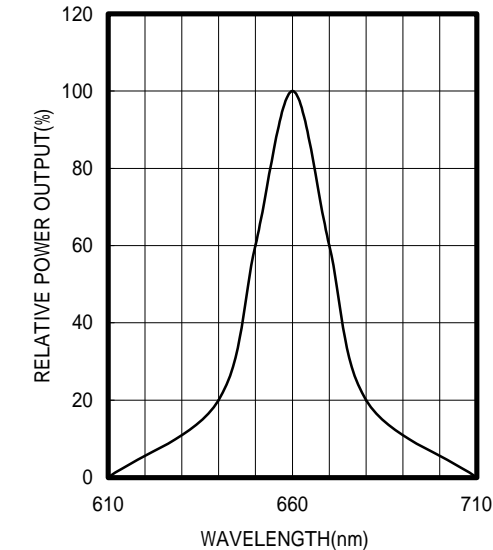

FORWARD I-V CHARACTERISTICS

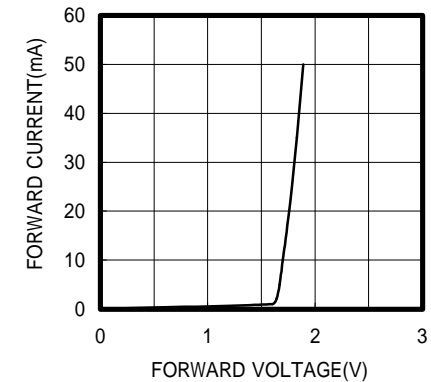

RELATIVE POWER vs FORWARD CURRENT

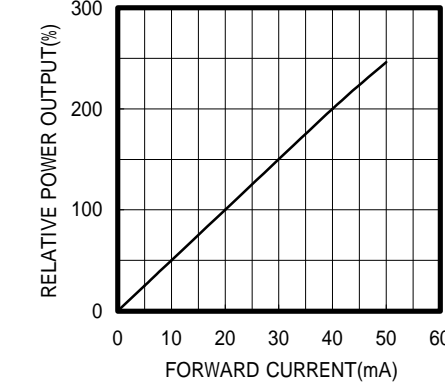

RADIATION PATTERN

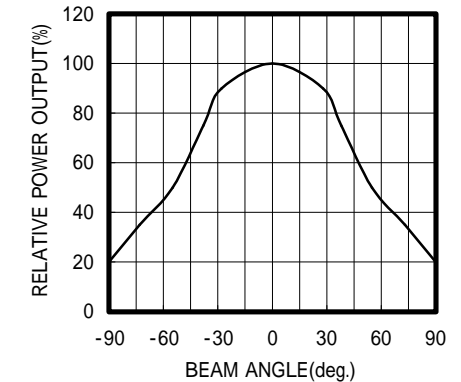

THERMAL DERATING CURVE

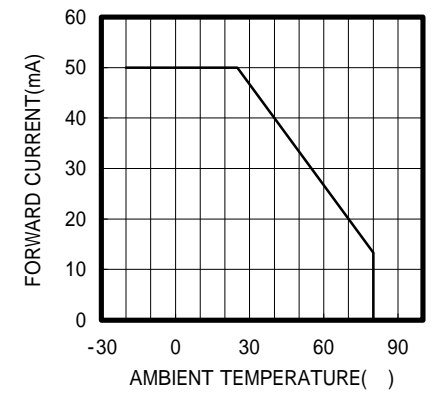

POWER OUTPUT vs TEMPERATURE IF=10mA

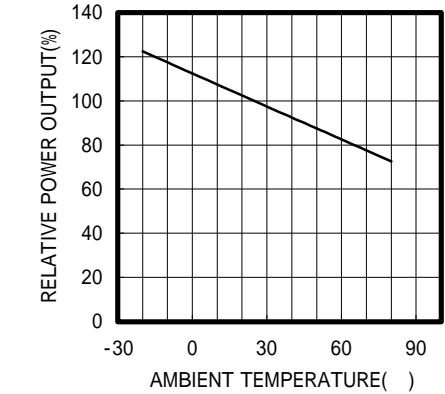

FORWARD VOLTAGE vs TEMPERATURE IF=10mA

